

ALFREDO TASCA
MASSIMO TASCA
RAFFAELE LAZZARI
STAUBACH & KUCKERTZ
ALESSANDRO LENARDA
SJIT
MARCO DE LUCA



PICNIC AREA: CONVIVIALITY IS OUTDOOR

Àrea pic nic:
la convivència es
al aire libre

AIR - CIRCLE





AIR - CIRCLE



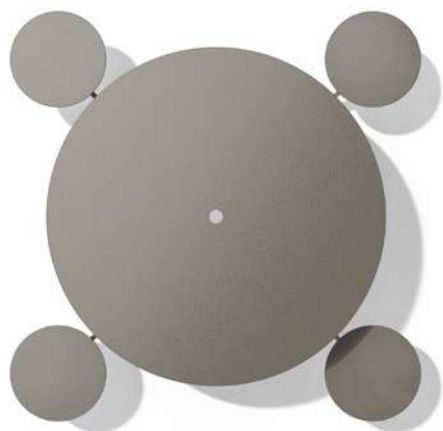

4

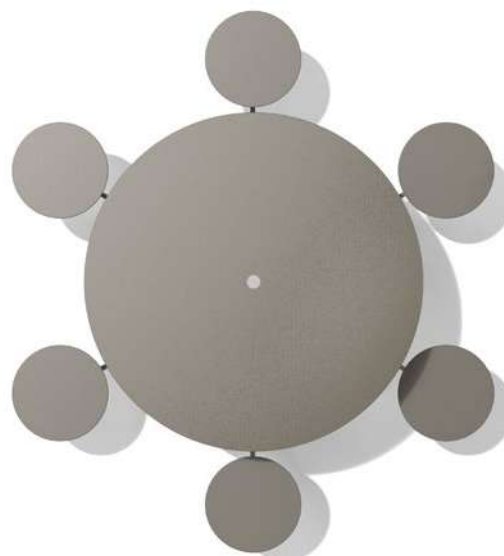

6

Collection of round tables with integrated stools, made of HPL (High Pressure Laminate), composed of a supporting structure in thick steel sheet, with proper tube connections for the seats and the table. Two versions are available: four-seater with two height-adjustable stools and six-seater with three height-adjustable stools.

Colección de mesas redondas con taburetes integrados, realizados en HPL (High Pressure Laminate), constituida de una estructura portante en una gruesa chapa de acero, con las correspondientes juntas en tubo para los asientos y la mesa. Disponibles en dos versiones: de cuatro plazas con dos taburetes regulables en altura y de seis plazas con tres taburetes regulables en altura.

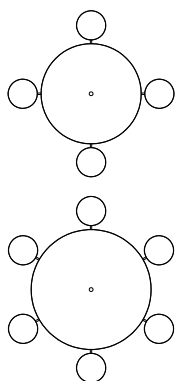
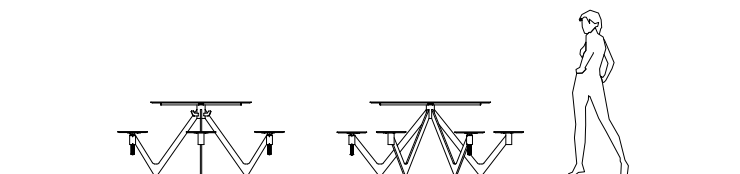

AIR - CIRCLE

Designer:	Massimo Tasca	
Dimensions and weight Dimensiones y peso:	4	53 kg
	1660x1660 mm	
	6	84 kg
	1860x1860	
	H 730 mm (table - mesa) h 434 mm (seat - asiento)	
Materials/Materiales:	Powder coated steel + HPL (High Pressure Laminate) Acero pintado + HPL (High Pressure Laminate)	
Fixing/Fijación:	Pre-drilled for anchors Predisposición para tacos	

BREAK TIME I





BREAK TIME I





BREAK TIME W

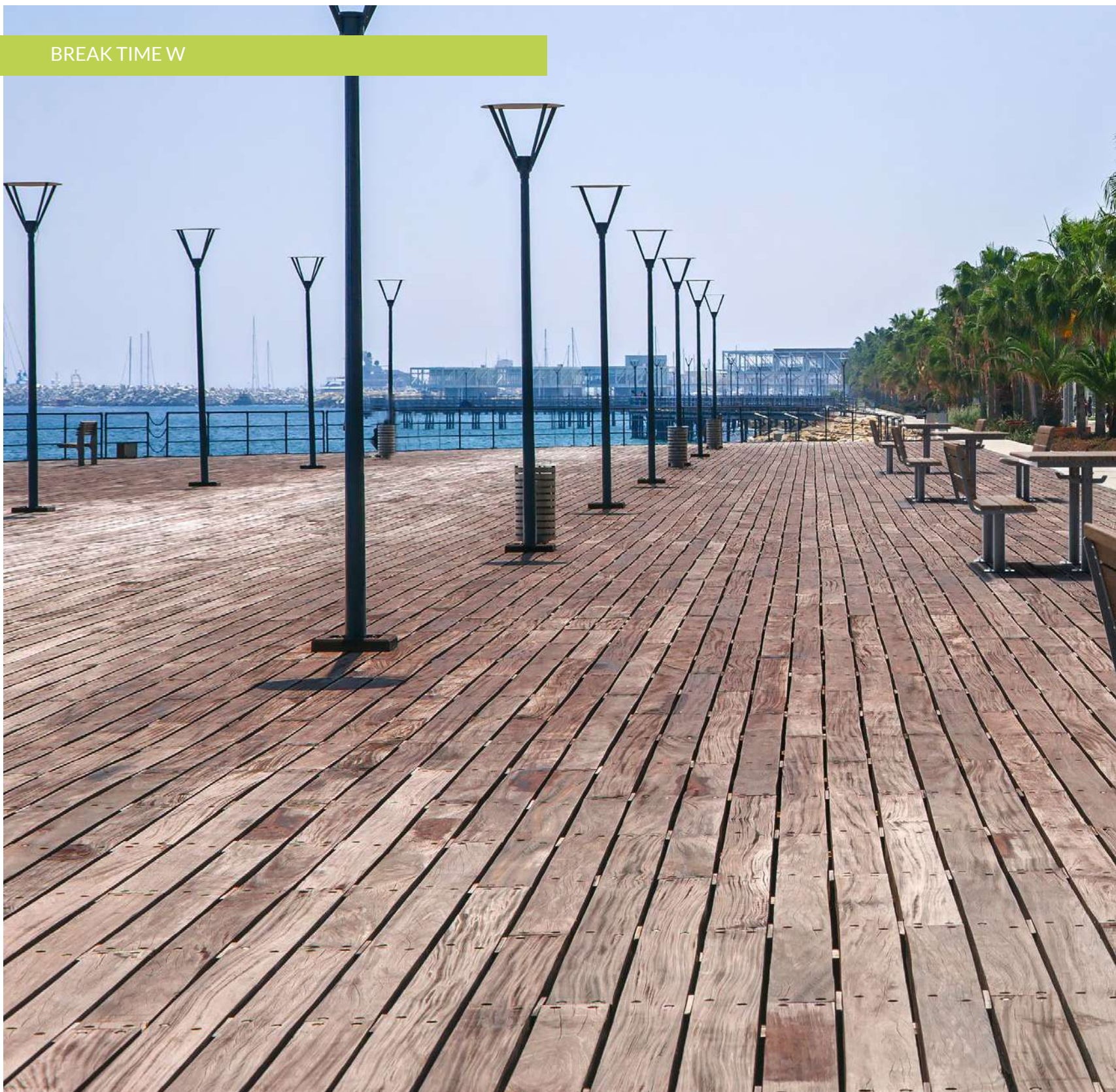







SI7S



SI7



SI4S



SI4



SIL

Collection of seats available in different models. SIL is a bench with backrest composed of a seat in steel rods and two supports in steel tube. The SI7S, SI7, SI4S, SI4 models are single seats, with different heights, with or without backrest, composed of a vertical support in steel tube and a seat in rods. The SI7S, SI7 models are equipped fixed footrest in stainless steel. The SI7S model is rotating with locking system, with backrest and armrests.

Colección de asientos disponibles en diferentes modelos. SIL es un banco con respaldo dotado de superficie que hace de asiento en varillas de acero y de dos soportes en tubo de acero. Los modelos SI7S, SI7, SI4S, SI4 son asientos monoplazas con o sin respaldo, de diferentes alturas, dotados de un soporte vertical en tubo de acero y de una superficie en varillas que sirve como asiento. Las versiones SI7S, SI7 disponen de reposapiés fijo en acero Inoxidable. El modelo SI7S es giratorio con sistema de bloqueo y está dotado de respaldo y apoyabrazos.

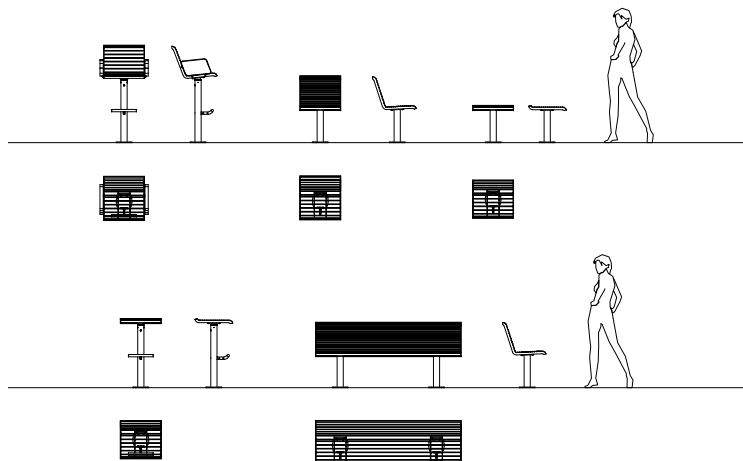

BREAK TIME I

Designer:	Massimo Tasca
Dimensions and weight Dimensiones y peso:	<p>SI7S 590x540 mm H 1180 mm h 850 mm 24 kg</p> <p>SI7 500x470 mm H 850 mm 16 kg</p> <p>SI4S 500x540 mm H 820 mm h 455 mm 16 kg</p> <p>SI4 500x470 mm H 455 mm 13 kg</p> <p>SIL 1800x540 mm H 820 mm h 455 mm 48 kg</p>

Materials/Materiales:	Powder coated steel Acero pintado
Fixing/Fijación:	Pre-drilled for anchors or Below ground installation Predisposición para tacos o Cimentación

BREAK TIME W





SW7S

SW7

SW4S

SW4

SWL

Collection of seats available in different models. SWL is a bench with backrest composed of a wooden seat and two steel supports. The SW7S, SW7, SW4S, SW4 models are single seats, with different heights, with or without backrest, equipped with a vertical support in steel tube and a wooden seat. The SW7S, SW7 models are equipped with fixed footrest in stainless steel. The SW7S model is rotating with locking system, with backrest and armrests.

Colección de asientos disponibles en diferentes modelos. SWL es un banco con respaldo formado de una superficie para sentarse de madera y dos soportes en acero. Los modelos SW7S, SW7, SW 4S, SW4 son asientos monoplazas con o sin respaldo, dotados de un soporte vertical en tubo de acero y de una superficie para sentarse de madera. Disponibles en dos alturas. Las versiones SW7S, SW7 disponen de apoyapiés fijo en acero Inoxidable. El modelo SW7S es giratorio, con sistema de bloqueo y está dotado de respaldo y apoyabrazos.

BREAK TIME W

Designer:

Massimo Tasca

Dimensions and weight
Dimensiones y peso:

SW7S
585x540 mm H 1990 mm h 850 mm
28 kg

SW7
500x460 mm H 850 mm
19 kg

SW4S
500x520 mm H 820 mm h 455 mm
21 kg

SW4
500x460 mm H 455 mm
16 kg

SWL
1800x520 mm H 820 mm h 455 mm
58 kg

Materials/Materiales:

Powder coated steel + Hardwood
Acero pintado + Madera dura

Fixing/Fijación:

Pre-drilled for anchors or Below ground
installation
Predisposición para tacos o Cimentación

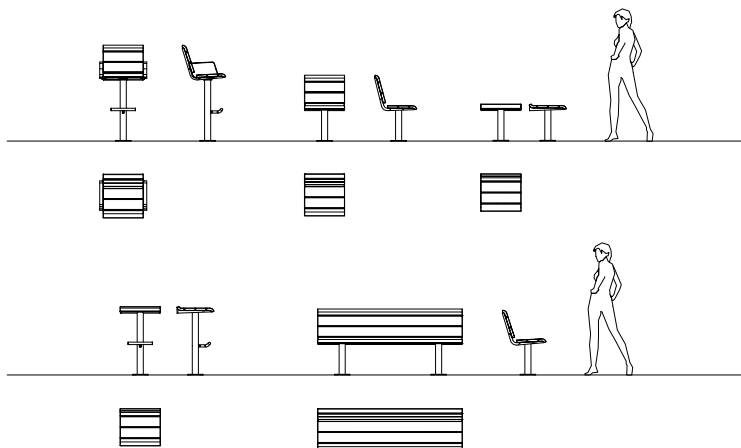

BREAK TIME TI







TIA



TIB



TIL

BREAK TIME TI

Designer:	Massimo Tasca		
Dimensions and weight Dimensiones y peso:	TIA	800x800 mm H 1205 mm	25 kg
	TIB	800x800 mm H 750 mm	23 kg
	TIL	1800x800 mm H 750 mm	69 kg
Materials/Materiales:	Powder coated steel Acero pintado		
Fixing/Fijación:	Pre-drilled for anchors or Below ground installation Predisposición para tacos o Cimentación		

Collection of tables available in different heights. The steel structure, with plane in rods, rests on tube supports. All tables are equipped with handbag hooks. The supports on the TIL model are positioned to be compatible with wheelchairs.

Colección de mesas disponibles en varias alturas. La estructura, en acero está formada por una superficie con varillas y un soporte en tubo. Todas las mesas están equipadas con ganchos para colgar el bolso. En la versión TIL los soportes se han posicionado para permitir el acceso a una silla de ruedas.

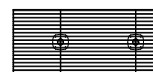
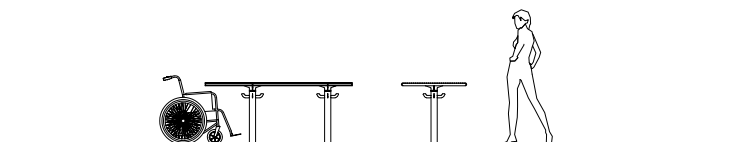
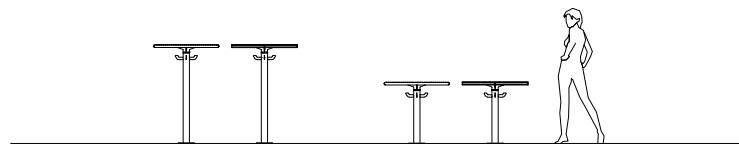



TWA

TWB

TWL

Collection of tables available in different heights. The steel structure, with plane in rods, rests on tube supports. All tables are equipped with handbag hooks. The supports on the TWL model are positioned to be compatible with wheelchairs.

Colección de mesas disponibles en varias alturas. La estructura, en acero está formada por superficie de madera y un soporte en tubo de acero. Todas las mesas están equipadas con ganchos para colgar el bolso. En la versión TWL los soportes se han posicionado para permitir el acceso a una silla de ruedas.

BREAK TIME TW

Designer:	Massimo Tasca	
Dimensions and weight Dimensiones y peso:	TWA 810x810 mm H 1205 mm	25 kg
	TWB 810x800 mm H 750 mm	32 kg
	TWL 1800x810 mm H 750 mm	66 kg
Materials/Materiales:	Powder coated steel + Hardwood Acero pintado + Madera dura	
Fixing/Fijación:	Pre-drilled for anchors or Below ground installation Predisposición para tacos o Cimentación	

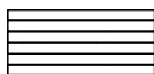
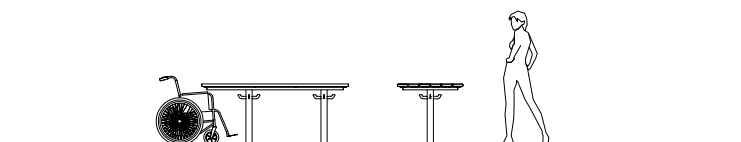
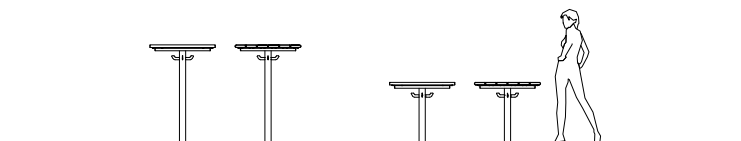

AIR - A

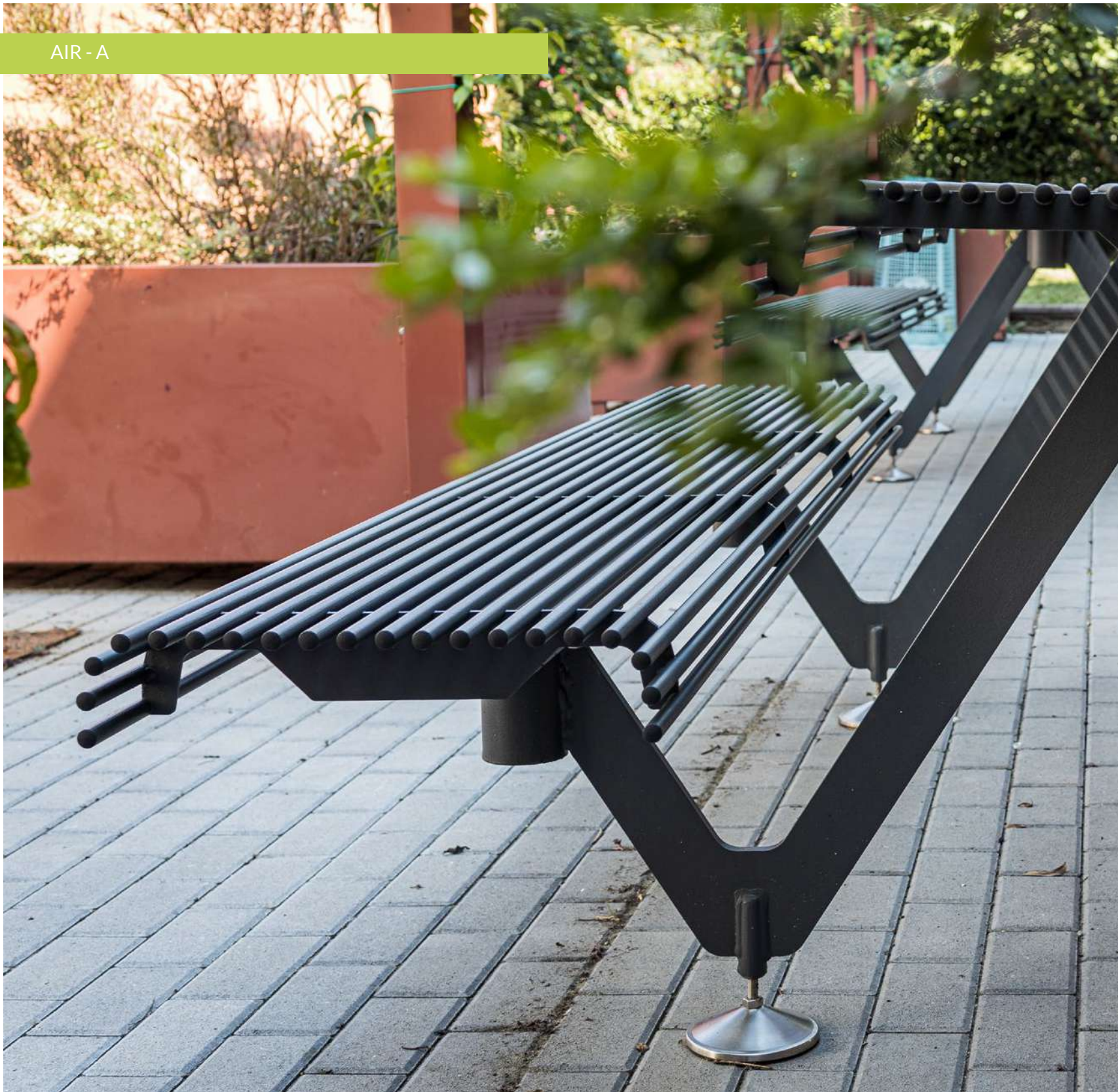



AIR - A

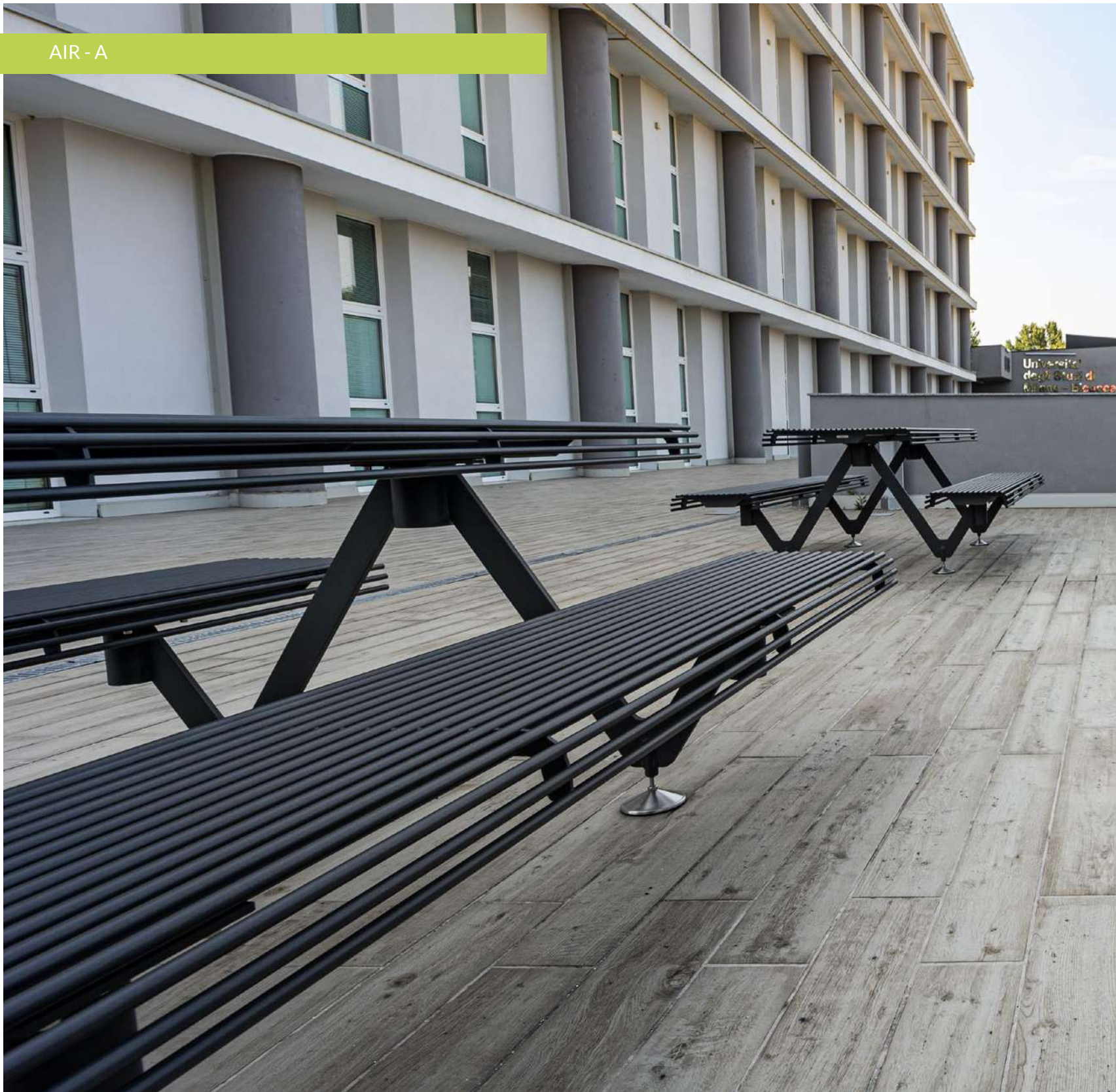

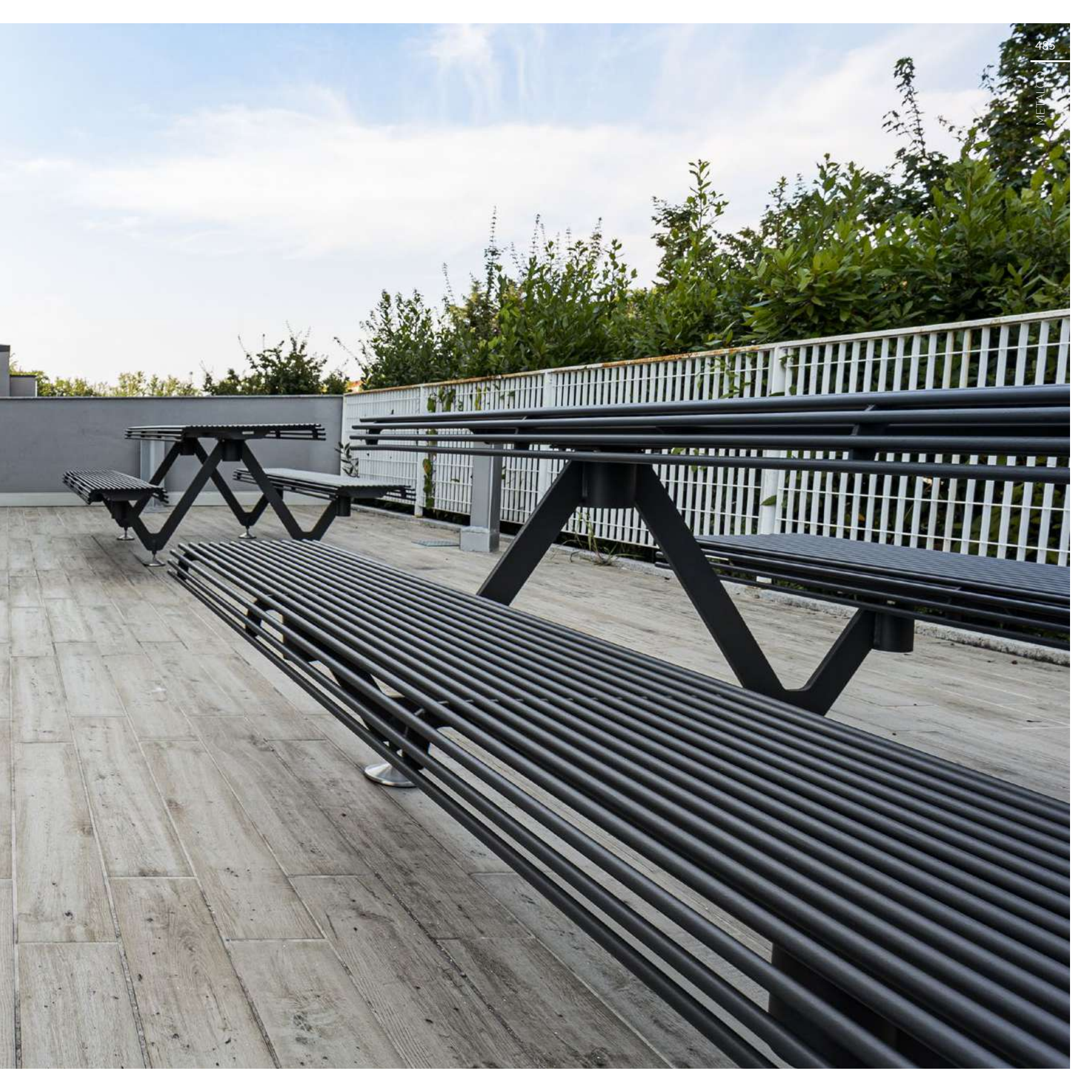



AIR - A

Designer:	Alfredo Tasca + Massimo Tasca + Raffaele Lazzari
Dimensions and weight Dimensiones y peso:	2200x1700 mm H 744 mm h 424 mm 178 kg
Materials/Materiales:	Powder coated steel Acero pintado
Fixing/Fijación:	Freestanding with pedestals or Installation with threaded bars Apoyo con pies o Cimentación con varillas roscadas
Accessories/Accesorios:	Anti-theft screws Tornillos antirrobo

Modular steel table with two integrated seats and composed of a supporting structure made of thick steel sheet and a plane in tubes.

Mesa modular con dos asientos integrados, realizados en acero y constituidos de una estructura portante en gruesa chapa de acero y de una base en tubos.

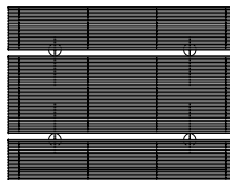
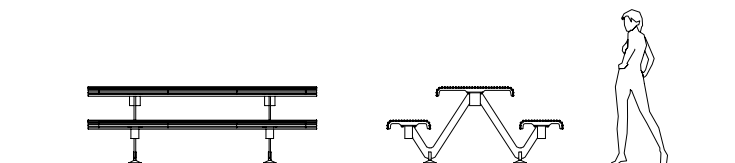



Modular steel table with integrated seats and composed of a thick steel sheet supporting structure, a plane and two wooden seats.

Mesa modular con asientos integrados, realizada en acero y constituida de una estructura portante en gruesa chapa de acero, de una base de apoyo y de dos asientos de madera.

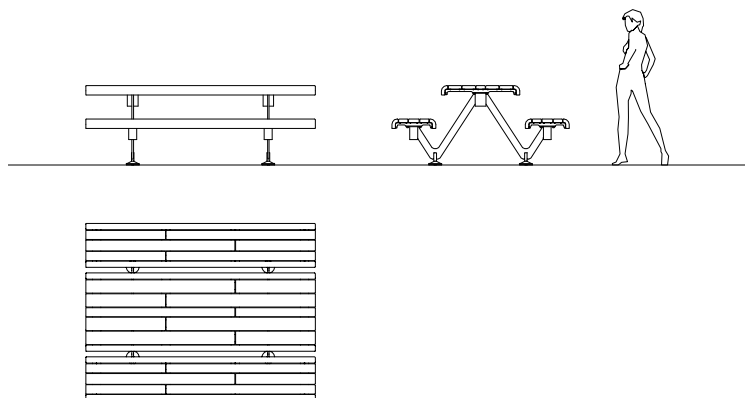

AIR - L

Designer:	Alfredo Tasca + Massimo Tasca + Raffaele Lazzari
Dimensions and weight Dimensiones y peso:	2200x1700 mm H 760 mm h 440 mm Hardwood Madera dura 222 kg Larch Alerce 190 kg
Materials/Materiales:	Powder coated steel + Hardwood or Larch Acero pintado + Madera dura o Alerce
Fixing/Fijación:	Freestanding with pedestals or Installation with threaded bars Apoyo con pies o Cimentación con varillas roscadas
Accessories/Accesorios:	Anti-theft screws Tornillos antirrobo

AIR - CS

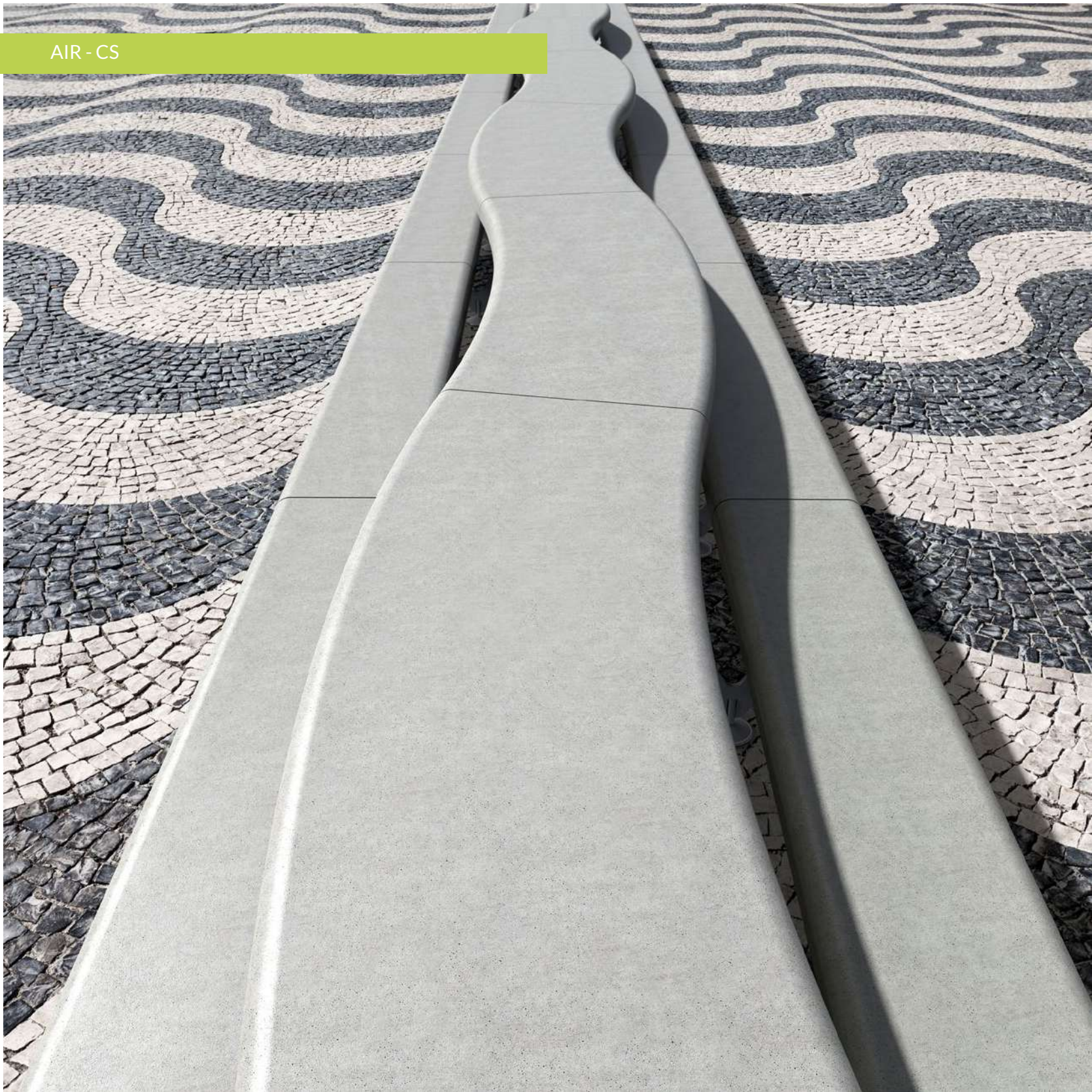



Collection of modular tables with integrated seats, made of UHPC (Ultra High Performance Concrete), composed of thick metal sheet supports, a plane and two seats in UHPC (Ultra High Performance Concrete). Two versions, linear or curved, are available.

Colección de mesas modulares con asientos integrados, realizados en UHPC (Ultra High Performance Concrete), constituidos de soportes gruesos en chapa de acero, de una base de apoyo y de dos asientos en UHPC (Ultra High Performance Concrete). Disponible en versión lineal o curva.

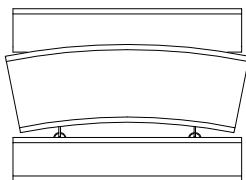
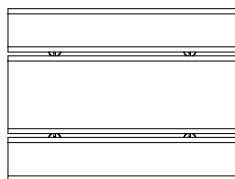
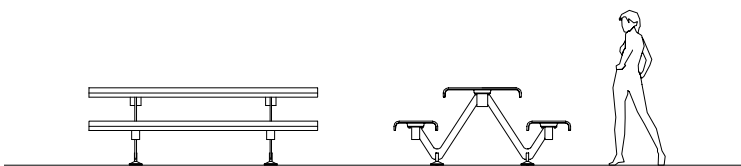

AIR - C | AIR - CS

Designer:	Alfredo Tasca + Massimo Tasca + Raffaele Lazzari
Dimensions and weight Dimensiones y peso:	2200x1660 mm H 744 mm h 424 mm 252 kg
Materials/Materiales:	UHPC (Ultra High Performance Concrete) + Powder coated steel UHPC (Ultra High Performance Concrete) + Acero pintado
Finishes/Acabados:	UHPC Alfa - Natural smooth UHPC Alfa - Liso natural
Fixing/Fijación:	Freestanding with pedestals or Installation with threaded bars Apoyo con pies o Cimentación con varillas roscadas
Accessories/Accesorios::	Anti-theft screws Tornillos antirrobo



B - B SASS

Designer:	Stauck & Kuckertz	
Dimensions and weight Dimensiones y peso:	Ø 653 mm H 813 mm	56 82 kg
Materials/Materiales:	Galvanized steel + Corten steel + Stainless steel Acero galvanizado + Acero Corten + Acero Inox	
Fixing/Fijación:	Freestanding Apoyo	

Collection of steel barbecue composed of a supporting structure in electrowelded mesh with sheet metal bottom, equipped with integrated brazier in Corten steel sheet and stainless steel grid with anti-theft chain. The supporting structure has to be filled with inert material not provided and chosen by the customer. The barbecue is available with a simple brazier or with a lower compartment for wood storage.

Colección de barbacoas en acero formadas por una estructura portante en malla electrosoldada con fondo de chapa, equipada con brasero integrado en chapa de acero Corten y parrilla en acero Inoxidable con cadena antirrobo. La estructura de soporte debe rellenarse con material inerte no suministrado y elegido por el cliente. La barbacoa está disponible con un brasero simple o con un compartimento inferior

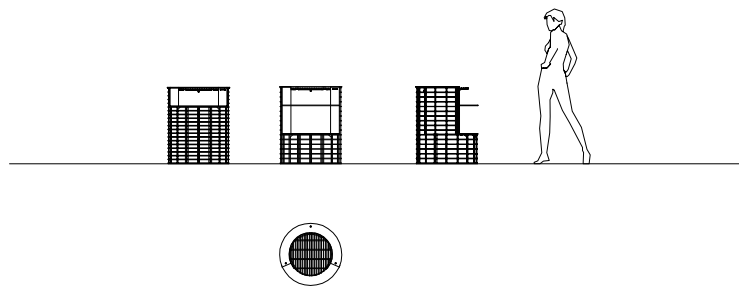



Barbecue made of Corten steel composed of a rotating top equipped with refractory plate and a stainless steel anti-theft grid, adjustable in three heights. The structure stands on a central support.

Barbacoa en acero Corten formada por una superficie giratoria equipada con una placa refractaria y una parrilla antirrobo de acero Inoxidable, regulable en tres alturas. La estructura se apoya sobre un soporte central.

B - BQ

Designer:	Massimo Tasca
Dimensions and weight Dimensiones y peso:	1030x740 mm H 990 mm 129 kg
Materials/Materiales:	Corten steel + Stainless steel Acero Corten + Acero Inox
Fixing/Fijación:	Below ground installation Cimentación

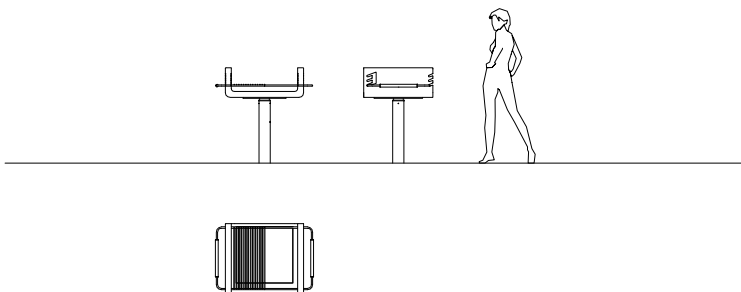



C - BQ

Designer:	Massimo Tasca
Dimensions and weight Dimensiones y peso:	1050x800 mm H 1060 mm 166 kg
Materials/Materiales:	Corten steel + Stainless steel Acero Corten + Acero Inox
Fixing/Fijación:	Below ground installation Cimentación

Barbecue made of Corten steel composed of a rotating top equipped with refractory plate and a stainless steel anti-theft grid, adjustable in three heights. The structure stands on an "L" support.

Barbacoa en acero Corten formada por una superficie equipada con una placa refractaria y una parrilla antirrobo de acero Inoxidable, regulable en tres alturas. La estructura se apoya sobre un soporte en "L".

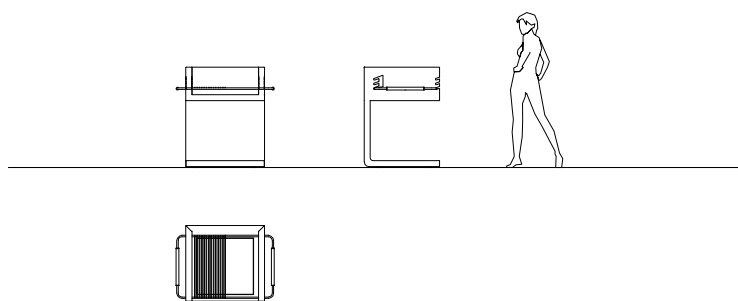



Collection of modular benches, with integrated table, made from the folding of a single laser cut metal sheet. Three sizes are available.

Colección de bancos modulares, con mesa incorporada, realizada del pliegue de una única chapa de acero cortada a láser. Disponible en tres tamaños.

MERENDA

Designer:	Alessandro Lenarda
Dimensions and weight Dimensiones y peso:	1990x1057 mm H 750 mm h 415 mm 173 kg
	1480x1057 mm H 750 mm h 415 mm 132 kg
	840x1057 mm H 750 mm h 415 mm 79 kg

Materials/Materiales: Powder coated steel or Corten steel
Acero pintado o Acero Corten

Fixing/Fijación: Pre-drilled for anchors
Predisposición para tacos

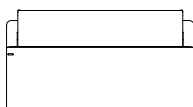
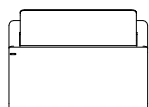
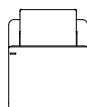
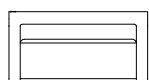



PIC BULL

Designer:	Sjit
Dimensions and weight Dimensiones y peso:	Seats - Asientos 2000x464 mm H 420 mm Hardwood Madera dura 56 kg Larch Alerce 44 kg
	Table - Mesa 2000x621 mm H 710 mm Hardwood Madera dura 81 kg Larch Alerce 64 kg
Materials/Materiales:	Powder coated steel or Corten steel + Hardwood or Larch Acero pintado o Acero Corten + Madera dura ou Alerce
Fixing/Fijación:	Pre-drilled for anchors Predisposición para tacos

Picnic table with matching seats composed of two supports in steel plate and a wooden top. The benches, without backrest, are composed of two steel plate supports and a wooden seat.

Mesa de picnic con dos bancos a juego, formados por dos soportes en placa de acero y por una superficie de madera. Los bancos, sin respaldo, están compuestos por dos soportes en placa de acero y por un asiento de madera.

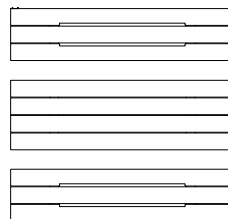
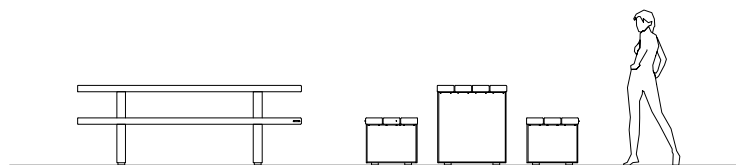



Picnic table with matching seats composed of two laser cut and decorated steel sheet supports and a wooden top. The benches, without backrest, are composed of two supports in laser cut and decorated steel sheet cut and laser decorated and a wooden seat.

Mesa de picnic con dos bancos a juego, formados por dos soportes en chapa de acero cortada y decorada a láser y por una superficie de madera. Los bancos, sin respaldo, están compuestos por dos soportes en chapa de acero cortada y decorada a láser y por un asiento de madera.

PICNIC

Designer: **Alfredo Tasca + Marco De Luca**

Dimensions and weight
Dimensiones y peso:

Seats - Asientos
1840x424 mm H 428 mm
Hardwood | Madera dura 45 kg
Larch | Alerce 38 kg

Table - Mesa
1840x710 mm H 718 mm
Hardwood | Madera dura 89 kg
Larch | Alerce 77 kg

Materials/Materiales:

Powder coated steel + Hardwood or Larch
Acero pintado + Madera dura o Alerce

Fixing/Fijación:

Pre-drilled for anchors
Predisposición para tacos

